



# GPS+GSM+WIFI Combination Antenna thick patch

## AN\_GPS\_GSM\_WF\_056



### Mechanical dimension

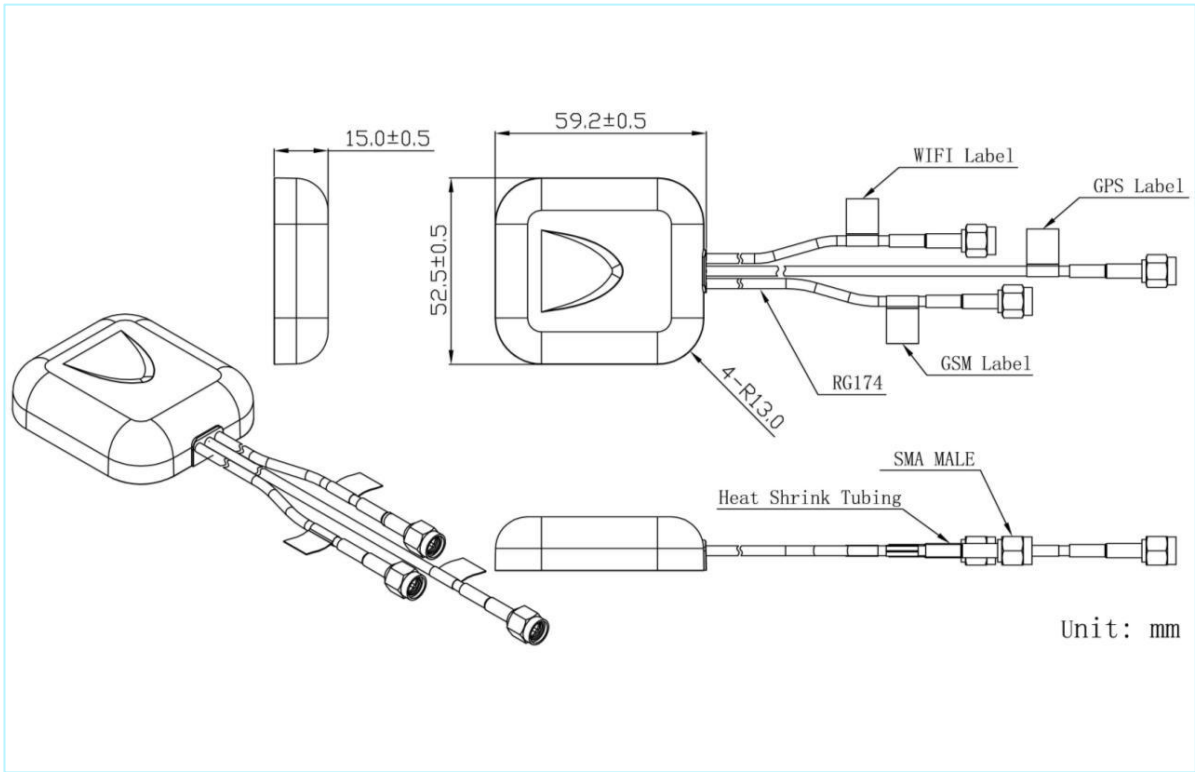

# GPS+GSM+WIFI Combination Antenna thick patch

## Specifications

Item		Specifications	
GPS Antenna	Dielectric Antenna	Center Frequency	1575.42±3MHz
		Band Width	CF±5MHz
		Polarization	RHCP
		Gain	2dBic (Zenith)
		V.S.W.R	<1.5
		Impedance	50Ω
	LNA	Gain	28±2dB
		Noise Figure	<1.5dB
		Ex-band Attenuation	12dB@CF+50MHz/16dB@CF-50MHz
		V.S.W.R	<2.0
		Supply Voltage	2.2~5V DC
		Current Consumption	<15mA
GSM Antenna	Frequency Range	824~960MHz/1710~2170MHz	
	V.S.W.R	<2.0(min)	
	Polarization	Linear	
	Gain	2.0dBi	
	Impedance	50Ω	
WIFI Antenna	Frequency Range	2400~2483.5MHz	
	Band Width	83.5MHz	
	Polarization	Linear	
	Gain	3dBi	
	V.S.W.R	<2.0(min)	
	Impedance	50Ω	
Mechanical	Cable	5 meters	
	Connector	SMA male for all the leads	
	Material	ABS	
	Mounting Method	Magnet	



# GPS+GSM+WIFI Combination Antenna thick patch

## Specifications

Environmental	Operating Temperature	-40°C~+85°C
	Relative Humidity	Up to 95%
	Ingress Protection	IP65~IP66(exclude cable outlet)
	Vibration	10 to 55Hz with 1.5mm amplitude 2hours
	Environmentally Friendly	ROHS Compliant

# GPS+GSM+WIFI Combination Antenna thick patch

## Radiation Patterns

GPS part Pattern

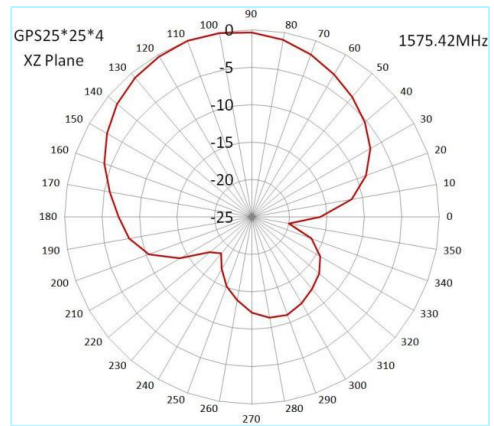
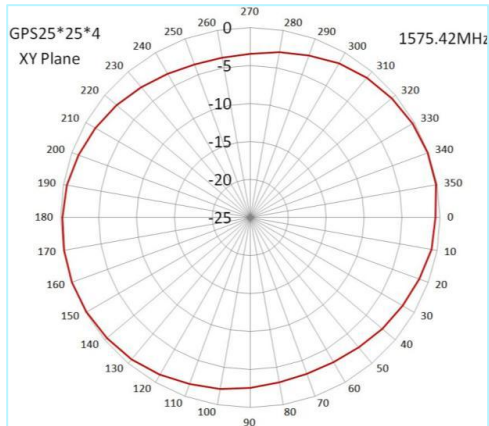

GSM Part Pattern

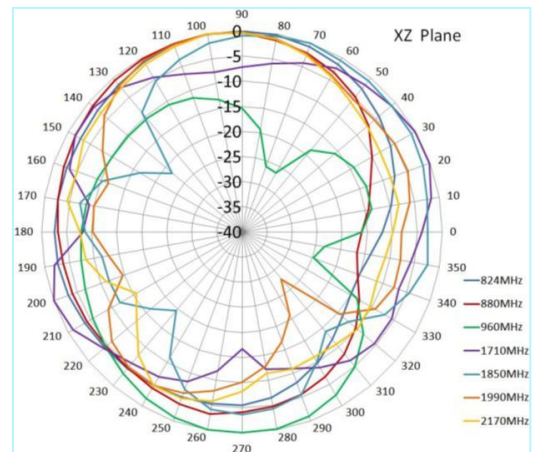
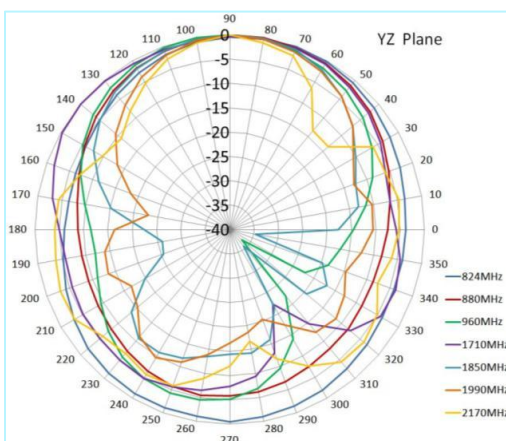
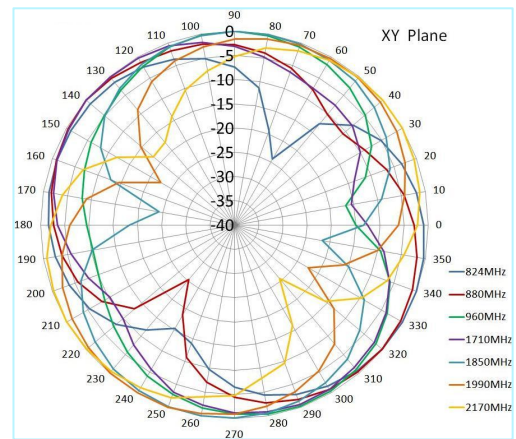
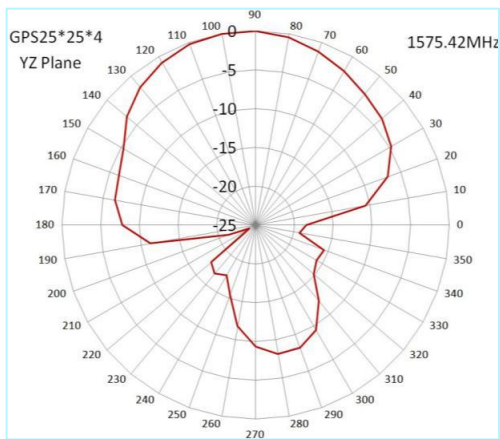

# GPS+GSM+WIFI Combination Antenna thick patch

## Radiation Patterns

WIFI part Pattern

